

WELDING SOLUTIONS FOR THE SHIPBUILDING INDUSTRY





INTRODUCTION	04
INDUSTRY INFORMATION	
Future of Shipbuilding Taking Shape Today	05
Ship Models	06
WELDING APPLICATIONS FOR THE SHIPBUILDING INDUSTRY	08
CONSUMABLE LIST FOR SHIPBUILDING	10
CONSUMABLE GUIDE	12
UNIQUE WELDING SOLUTIONS	
EGW – Electro Gas Welding	16
Tandem FCAW – Gantry Welding	17
Submerged Arc Welding On FGB (Fiber Glass Backing)	17
PRODUCT HIGHLIGHT	
SC-420MC	18
Supercored 71H	19
Supercored 70MXH	20
Superflux 55ULT / H-14	21
Flux Cored Wires for Low Temperature Applications in LPG Carriers	22
Welding Consumables for Outfitting	23
PACKAGING SPECIFICATIONS	24
REFERENCES	26



HYUNDAI WELDING BELONGS TO THE PAST, PRESENT AND FUTURE OF SHIPBUILDING

Today's global economy would be unthinkable without the shipping industry, connecting economies all over the world by means of cost-efficient transportation overseas. It is a highly competitive sector comprising a wide chain of activities; from the new construction of vessels to the building of harbours with (off)loading equipment and infrastructure over land to end users. A great part of shipbuilding involves the fabrication of large ocean-going container ships, bulk carriers, tankers and specialised carriers for e.g. chemicals, LPG and LNG.

As a full daughter of the Hyundai conglomerate – owner of some of the world's largest and most advanced shipyards – we participated in the rise of South Korea to become the world's number one shipbuilding nation by the end of the 20th century. We understand the complex industrial challenges of the shipbuilding industry and its need for innovative welding solutions, quality and productivity.

In partnership with shipyards all over the world, we have developed a vast range of dedicated welding consumables for panel lines and for subsequent assembly steps until finalisation in the dry dock. These include highly productive innovations such as one-sided submerged arc welding on fibre glass backing, double-sided tandem gantry welding with flux-cored wires and electro gas welding with flux-cored wires.

We build up our expertise in shipbuilding during 40 years of partnership with yards all over the world and are looking forward to meeting the challenges that lie ahead in welding the fleet of the future.



FUTURE OF SHIPBUILDING TAKING SHAPE TODAY

Today, major shipbuilding companies are mostly located in the Far East, most notably in China, Japan and South Korea. As from the seventies, the western world saw a huge decline in shipbuilding, although it still possesses a number of specialised yards and remains an active center for commercial shipbuilding.

The shipbuilding industry as a whole faces a number of challenges. It is beginning to implement new technologies such as 3D printing, flexible robots, laser cladding machines and virtual & augmented reality, in already highly efficient fabrication. At the same time, there is a persistent worldwide overcapacity that may encourage governments to subsidise yards and create market distortions which may affect even the most efficient shipbuilding industries.

Against this background, the OECD working party on shipbuilding (WP6) tries to regulate the industry by establishing normal competitive conditions, encouraging transparency and consultation with both non-OECD economies and relevant industry groups.

A major development is the use of new ship engines fuelled by LNG to reduce carbon emissions. Europe's leading clean transport campaign group NGO Transport & Environment (T&E) expects that by 2030, a quarter of European shipping will run on LNG. This percentage may increase drastically with a continuation of the energy security issue and new regulations on sulphur emission. The more distant future may see a surge in ammonia carriers to transport hydrogen generated at locations with lots of wind and sun to economies with a need for green energy.



SHIP MODELS

The shipbuilding industry has evolved significantly over time, driven by a steady flow of new technologies, materials and construction methods. Today, a great variety of vessels roam the world's oceans, seas, rivers and other waterways – built by shipyards with each their own specialisation and naval market coverage. Following overview reviews the main vessel types used for overseas transportation of cargo.

TANKER

It is a type of ship or vessel designed to transport large quantities of liquid cargo, such as crude oil, petroleum products and chemicals.



Chemical Tanker

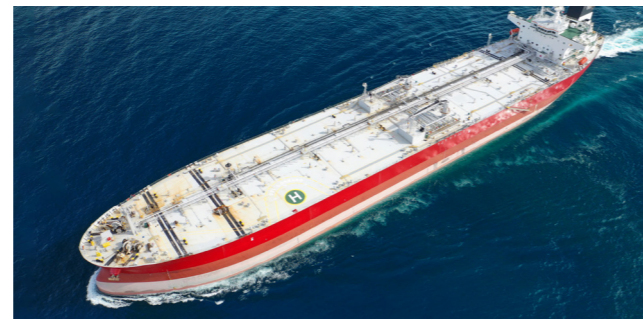

Crude Oil Tanker

CONTAINERSHIP

A type of cargo ship designed to transport cargo compacted in standard shipping containers. These containers are typically 20 or 40 feet in length and are loaded onto the ship using cranes or other equipment.

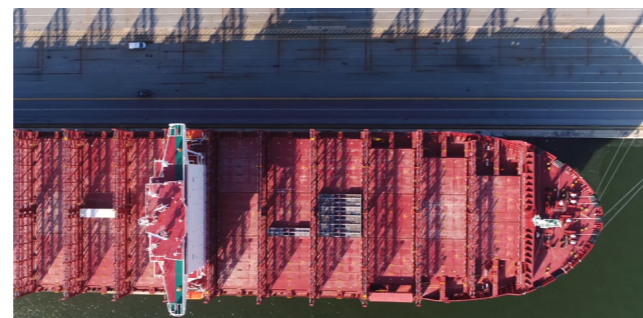

LNG & LPG CARRIERS

These carriers are specialized types of ships that are designed to transport liquefied natural gas (LNG) and liquefied petroleum gas (LPG) from one location to another.



LNG Carrier

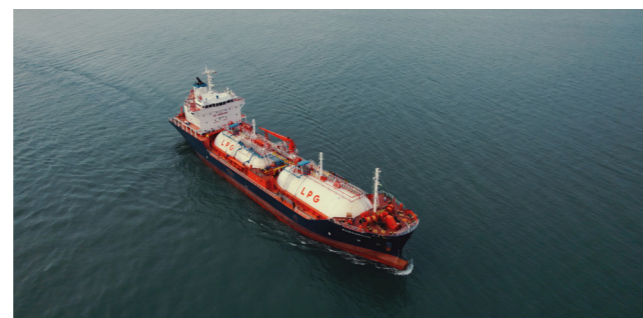

LPG Carrier

FSRU & FPSO

FSRU (Floating Storage and Regasification) is a vessel with the capability to vaporize liquefied gas taken from an LNG Carrier and load it into a transmission or distribution network without having a regasification terminal on land. FPSO (Floating Production Storage and Offloading) is a vessel with gas processing and liquefaction capability to tap directly into remote offshore fields and load it onto an LNG Carrier instead of performing the same process investment on land.



FSRU

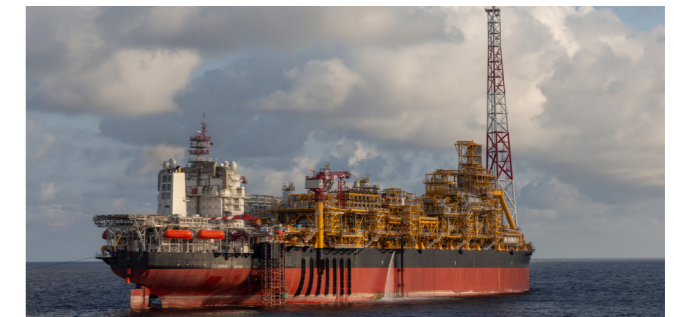

FPSO

DRILLSHIP

A specially designed vessel equipped with a drilling rig to drill into offshore oil or gas fields.



BULK CARRIER, PCTC & RO-RO SHIP

A bulk carrier is a type of ship designed to transport large quantities of dry cargo such as grain, coal, iron ore, and other commodities in bulk. The PCTC (Pure car, truck carrier) is a purpose-built vessel for the transportation of different types of rolling cargo, such as new private cars and trucks, heavy construction equipment, and other heavy loads. Roll-on/roll-off (Ro-Ro) ships are cargo ships designed to carry wheeled cargo, such as cars, motorcycles, trucks, semi-trailer trucks, buses, trailers, and railroad cars, that are driven on and off the ship on their own wheels or using a platform vehicle.



Bulk Carrier



PCTC



Ro-ro Ship

WELDING APPLICATIONS FOR THE SHIPBUILDING INDUSTRY

General Shipbuilding Process – Main Stages

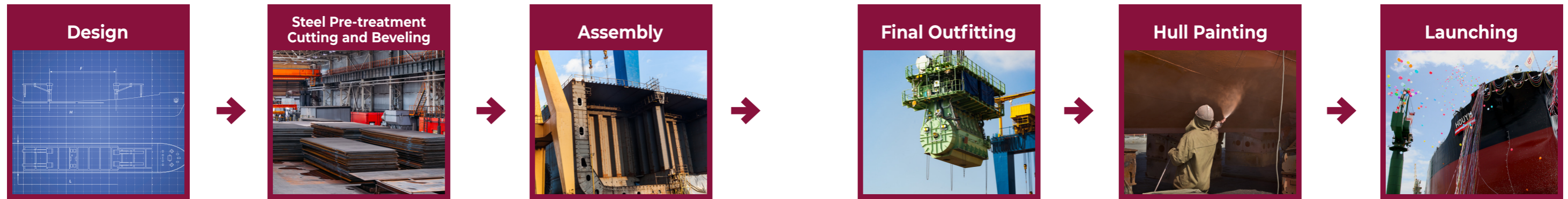

General Shipbuilding Process – Main Welding Stages of Assembly

Plate and Panel Assembly

Ship construction, regardless the size, starts with the welding of the hull plates and re-inforce them with stiffeners. The hull design determines the model of the ship, its streamlining and its overall aesthetics. The hull as such must be capable to withstand the forces acting upon it at sea and carry the weight of the cargo.

SAW / FCAW
(Automated)

Sub Assembly

It is the process of assembling smaller parts or components of a ship to form larger units, before they are joined to the final structure. The sub-assemblies are usually built in a dedicated area of the shipyard, in such a way that most of the welding can be done in the favourable downhand position.

FCAW
(Automated, Manual)

Block & Unit Assembly

Block assembly is the process of joining sub assembled sections to form a block structure. These blocks are subsequently welded to become units, which, after intermediate outfitting, are ready for final assembly in the dry dock. The size of blocks and units is determined by the available work floor space and the lifting capacities of the cranes.

FCAW
(Automated, Manual)

Dry Dock Assembly

It is the final stage in the assembly process, where all pre-fabricated units are brought together to form the complete vessel. This typically involves the positioning and joining of hull sections, decks, bulkheads and superstructure, as well as the installation of the propulsion system, electrical and control systems and other equipment. This stage typically takes place in a dry dock or on a slipway and involves the use of cranes, scaffolding and other specialized equipment to position and join the components.

FCAW /EGW
(Automatic, Manual)

Steel Grades & Mechanical Properties

Steel grades according to Classification Societies rules(ref. 5)					Comparable steel grades				
Grade	Yield stress Re min. N/mm ²	Tensile strength Rm N/mm ²	Elongation A5 min. %	Average	Impact energy		EN EN 10025-93 EN 10113-93	ASTM A131	JIS G 3106
				Temp. °C	J. min.	L			
A B D E	235	400-520	22	+20 0 -20 -40	- 27 27 27	- 20 20 20	S235JRG2 S235J0 S235J2G3 S275NL/ML	A B D E	SM400A (SM400C)
A 27 D 27 E 27	265	400-530	22	0 -20 -40	27	20	S275J0G3 S275N/M S275NL/ML	- - -	- - -
A 32 D 32 E 32	315	440-590	22	0 -20 -40	31	22	- - -	AH32 DH32 EH32	SM490B (SM490C) -
A 36 D 36 E 36	355	490-620	21	0 -20 -40	34	24	S355N/M S355N/M S355NL/ML	AH36 DH36 EH36	SM520B (SM520C) -
A 40 D 40 E 40	390	510-650	20	0 -20 -40	41	27	S420N/M S420N/M S420NL/ML	AH40 DH40 EH40	SM570 - -

CONSUMABLE LIST FOR SHIPBUILDING

Process	Consumable	Division						Process				Position acc. ASME and ISO				Steel grade					Shielding gas			Remarks
		Plate / Panel	Stiffener	Panel line Stiffener assembly	Sub Assembly Flat Stiffened panels	Block and Unit assembly	Dry dock assembly Erection	Other	Method	Joint	1G/PA	2F/PB	2G/PC	3Fd / PG 3Fu / PF	AH36	DH36	EH36	FH36	EH40	CO ₂	Ar+20%CO ₂	Dual Gas		
GMAW	SM-70		●	●	●				Manual / Carriage			●	●		●	●	●				●	CO ₂ & Ar+20%CO ₂ : DH36 Ar+20%CO ₂ : EH36		
FCAW	SL-71MAG		●	●					Manual / Carriage			●	●	●	●	●	●				●	Seamless cored wire		
	SL-71		●	●					Manual / Carriage			●	●	●	●	●			●			Seamless cored wire		
	Supercored 70NS		●	●					Manual / Carriage			●	●		●	●					●	Metal cored wire		
	SC-70ML		●	●					Manual / Carriage			●	●		●	●	●				●	Metal cored wire		
	SC-70A		●	●					Manual / Carriage			●	●		●	●						●	Metal cored wire	
	SC-70T Cored		●	●					Manual / Carriage			●	●		●	●						●	Metal cored wire	
	SF-71		●	●					Manual / Carriage			●	●	●	●					●				
	SF-70MX		●	●					Manual / Carriage			●	●		●					●				
	Supercored 71		●	●					Manual / Carriage			●	●	●	●	●				●				
	SC-71LH		●	●	●				Manual / Carriage			●	●	●	●	●				●				
	SC-71LHM Cored		●	●	●				Manual / Carriage			●	●	●	●	●					●			
	SC-420MC		●	●	●				Manual / Carriage			●	●	●	●	●						●		
	Supercored 71H		●	●	●				Manual / Carriage			●	●	●	●	●	●			●				
	SC-71MJ		●	●					Manual / Carriage			●	●	●	●	●	●				●			
	Supercored 70MXH		●						Twin Tandem (gantry)				●		●	●				●				
	SC-80K2		●						Twin Tandem (gantry)				●		●	●	●	●		●				
	Supercored 81-K2					●	●		Manual / Carriage			●	●	●	●	●	●	●	●	●			Hatch Coaming	
	Supercored 81MAG					●	●		Manual / Carriage			●	●	●	●	●	●	●	●		●		Hatch Coaming	
	SC-EG2 Cored					●		●	EGW*	Carriage				●	●	●				●			for side shell welding	
	SC-EG3					●		●	EGW*	Carriage				●	●	●	●	●	●	●			for side shell welding	
Supercored 81-K2 (root) + SC-EG2 Cored (fill)							●	Combine	Manual / Carriage				●	●	●				●			for side shell welding		
Supercored 81-K2 (root) + SC-EG3 (fill)							●	Combine	Manual / Carriage				●	●	●	●	●	●	●			for side shell welding		
SAW	S-777Q/H-14		●	●					Single & Double side single run	I joint		●	●		●									
	Superflux 55ULT/H-14	●							Double side single & multi run	I Y X joints		●			●	●	●	●	●					
	Superflux 55ULT/A-3	●							Double side single run	I Y X joints		●			●	●	●	●	●					
	S-705EF/H-14 + IRN or CW	●						FGB*	Single side single run	V joint		●			●	●						MAX plate thickness 22.5 mm		
	Supercored 81-K2 + Superflux 55ULT/H-14	●						Combine	Multi run	V joint		●			●	●	●	●	●			Root FCAW and fill SAW		
S-707T/H-14	●						FCB*	Single side single run	V joint		●			●								One flux for welding and backing		

* FGB - Fibre glass (ceramic) Backing | FCB = Flux and Copper Backing | EGW = Electro Gas Welding

TYPICAL MECHANICAL PROPERTIES AND CHEMICAL COMPOSITION (%) OF ALL-WELD METAL

Process	Product Name	AWS	EN ISO	Typical Chemical Composition of All-Weld Metal(%)								Typical Mechanical Properties of All-Weld Metal					
				C	Si	Mn	P	S	Ni	Mo	As Welded / PWHT	YS MPa(lbs/in ²)	TS MPa(lbs/in ²)	EL (%)	Impact ISO-V		
															°C (°F)	J (ft-lbs)	
GMAW	SM-70**/*	A5.18 ER70S-6	ISO 14341-A-G 42 2 C1 3Si1	0.07	0.58	1.15	0.010	0.010	-	-	As Welded	467 (67,700)	566 (82,100)	28	-30 (-20)	71 (52)	
			ISO 14341-A-G 42 5 M21 3Si1	0.07	0.64	1.24	0.010	0.010	-	-	As Welded	472 (68,500)	569 (82,500)	26	-50 (-60)	60 (44)	
FCAW	SL-71MAG*	A5.20 E71T-1M/-9M H4	ISO 17632-A-T 46 4 P M21 1 H5	0.04	0.43	1.41	0.017	0.005	-	-	As Welded	540 (78,300)	580 (84,200)	28	-40 (-40)	55 (41)	
	SL-71**	A5.20 E71T-1C/-9C H4	ISO 17632-A-T 46 3 P C1 1 H5	0.05	0.37	1.47	0.011	0.007	-	-	As Welded	520 (75,400)	590 (85,600)	28	-30 (-20)	70 (52)	
	Supercored 70NS*	A5.18 E70C-6M	ISO 17632-A-T 42 3 M M21 3 H5	0.05	0.55	1.45	0.011	0.010	-	-	As Welded	480 (69,700)	550 (79,800)	25	-30 (-20)	50 (37)	
	SC-70ML*	A5.18 E70C-6M	ISO 17632-A-T 46 4 M M21 2 H5	0.04	0.56	1.57	0.011	0.014	0.35	-	As Welded	476 (69,000)	553 (81,200)	27	-40 (-40)	75 (55)	
	SC-70A**/*	A5.18 E70C-6M	A5.18 E70C-3C	ISO 17632-A-T 42 3 M C1 1 H5	0.06	0.40	1.40	0.011	0.008	-	-	As Welded	500 (72,500)	560 (81,200)	27	-30 (-20)	50 (37)
			ISO 17632-A-T 46 3 M M21 1 H5	0.06	0.52	1.50	0.010	0.009	-	-	As Welded	540 (78,300)	610 (88,500)	26	-30 (-20)	70 (52)	
	SC-70T Cored**/*	A5.18 E70C-6M	A5.18 E70C-3C	ISO 17632-A-T 42 2 M C1 1	0.06	0.60	1.20	0.011	0.012	-	-	As Welded	473 (68,600)	550 (79,800)	29	-20 (0)	53 (39)
			ISO 17632-A-T 46 2 M M21 1 H5	0.07	0.65	1.41	0.010	0.011	-	-	As Welded	532 (77,200)	589 (85,500)	27	-30 (-20)	65 (48)	
	SF-71**	A5.20 E71T-1C	ISO 17632-A-T 42 0 P C1 1	0.04	0.49	1.29	0.010	0.009	-	-	As Welded	548 (79,600)	582 (84,500)	28	-20 (0)	45 (33)	
	SF-70MX**	A5.20 E70T-1C	ISO 17632-A-T 42 0 R C1 3	0.05	0.50	1.50	0.011	0.013	-	-	As Welded	560 (81,300)	590 (85,700)	28	-20 (0)	50 (37)	
	Supercored 71**	A5.20 E71T-1C	ISO 17632-A-T 42 2 P C1 1	0.03	0.51	1.26	0.010	0.011	-	-	As Welded	545 (79,100)	572 (83,100)	28	-20 (0)	70 (52)	
	SC-71LH**	A5.20 E71T-1C/-9C	ISO 17632-A-T 42 2 P C1 1 H5	0.06	0.47	1.35	0.014	0.012	-	-	As Welded	550 (79,900)	590 (85,600)	27	-30 (-20)	70 (52)	
	SC-71LHM Cored*	A5.20 E71T-1M/-9M	ISO 17632-A-T 46 3 P M21 1 H5	0.05	0.50	1.20	0.012	0.015	-	-	As Welded	580 (84,200)	600 (87,100)	28	-30 (-20)	80 (59)	
	SC-420MC**/*	A5.20 E71T-1M/-9M H8	A5.20 E71T-1C/-9C H4	ISO 17632-A-T 46 3 P C1 1 H5	0.03	0.45	1.15	0.010	0.006	-	-	As Welded	520 (75,400)	570 (82,700)	28	-30 (-20)	50 (37)
			ISO 17632-A-T 46 3 P M21 1 H5	0.04	0.60	1.35	0.010	0.006	-	-	As Welded	575 (83,400)	630 (91,400)	26	-30 (-20)	60 (44)	
	Supercored 71H**	A5.20 E71T-1C/-9C/-9C-J	ISO 17632-A-T 42 4 P C1 1 H5	0.03	0.46	1.36	0.008	0.011	0.40	-	As Welded	550 (79,900)	570 (82,800)	27	-40 (-40)	60 (44)	
	SC-71MJ*	A5.20 E71T-9M-J	ISO 17632-A-T 46 4 P M21 1 H5	0.06	0.30	1.10	0.012	0.011	0.42	-	As Welded	545 (79,100)	583 (84,500)	25	-40 (-40)	80 (59)	
	Supercored 70MXH**	A5.20 E70T-1C/-9C	ISO 17632-A-T 42 2 R C1 3 H5	0.05	0.55	1.65	0.013	0.010	-	-	As Welded	540 (78,400)	620 (90,000)	28	-30 (-20)	54 (40)	
	SC-80K2**	A5.29 E80T1-K2C	ISO 17632-A-T 46 6 1.5Ni R C1 3 H5	0.06	0.43	1.45	0.011	0.008	1.57	-	As Welded	575 (83,400)	635 (92,100)	26	-60 (-75)	60 (44)	
	Supercored 81-K2**	A5.29 E81T1-K2C H4	ISO 17632-A-T 46 6 1.5Ni P C1 1 H5	0.04	0.35	1.35	0.012	0.011	1.50	-	As Welded	540 (78,400)	620 (90,000)	28	-60 (-75)	60 (44)	
Supercored 81MAG*	A5.29 E81T1-Ni1M H4	ISO 17632-A-T 50 6 1Ni P M21 2 H5	0.05	0.28	1.20	0.008	0.012	0.93	-	As Welded	550 (79,900)	590 (85,700)	26	-60 (-75)	60 (44)		
SAW	S-777Q/H-14	A5.17 F7A2-EH14	ISO 14174-S A AR1 / ISO 14171-A-S4	0.07	0.36	1.49	0.018	0.011	-	-	As Welded	510 (74,000)	587 (85,100)	30	-30 (-20)	66 (49)	
	Superflux 55ULT/H-14	A5.17 F7A(P)8-EH14	ISO 14174-S A FB1 / ISO 14171-A-S4	0.07	0.21	1.51	0.019	0.008	-	-	As Welded	530 (76,900)	580 (84,200)	30	-60 (-75)	120 (88)	
	Superflux 55ULT/A-3	A5.23 F8TA8-EA3	ISO 14174-S A FB1 / ISO 14171-A-S4Mo	0.06	0.26	1.40	0.011	0.001	-	0.16	As Welded	530 (77,000)	625 (91,000)	27	-60 (-75)	71 (52)	
	S-777Q/M-12K	A5.17 F7A2-EM12K	ISO 14174-S A AR1 / ISO 14171-A-S2Si	0.06	0.43	1.01	0.015	0.011	-	-	As Welded	462 (67,000)	552 (80,000)	32	-30 (-20)	50 (37)	

* With M21 Shielding Gas

** With C1 Shielding Gas

*/ ** Can be used with M21 and C1 Shielding Gas. Information belongs to M21 Shielding Gas

APPROVALS

Process	Product Name	AWS	EN ISO	CWB	TÜV	DB	CE	NAKS	KR	ABS	LR	BV	DNV	NK	RS	RINA	CCS	CRS
GMAW	SM-70	A5.18 ER70S-6	ISO 14341-A-G 42 2 C1 3Si1 ISO 14341-A-G 42 5 M21 3Si1	✓	✓	✓	✓	✓	3SG, 3YSG(C), 3YSG(M2), 3YMG(M2)	3SA, 3YSA	3YS, 3YM H15	SA3, SA3YM	IIIYMS	KSW53G(C), KSW53G(M2), KSW53MG(M2)	3YSM	3YS	-	-
FCAW	SL-71MAG	A5.20 E71T-1M/-9M H4	ISO 17632-A-T 46 4 P M21 1 H5	-	-	-	✓	-	-	-	4Y40S	SA3Y40 HHH	IIIY40MS H5	-	-	-	-	
	SL-71	A5.20 E71T-1C/-9C H4	ISO 17632-A-T 46 3 P C1 1 H5	-	-	-	✓	-	-	3YSA H5	3YS	-	-	-	-	-	-	
	Supercored 70NS	A5.18 E70C-6M	ISO 17632-A-T 42 3 M M 21 3 H5	✓	✓	✓	✓	-	3YSG(M2) H5	3SAH5, 3YSA	3YSH5	SA3M, SA3YM HHH	IIIYMS H5	-	-	3YS H5	-	
	SC-70ML	A5.18 E70C-6M	ISO 17632-A-T 46 4 M M21 2 H5	✓	✓	✓	✓	-	-	4Y400SA H5	4Y40S H5	SA4Y40M HHH	IVY40MS H5	-	-	4Y40S H5	-	
	SC-70A	A5.18 E70C-3C / E70C-6M	ISO 17632-A-T 42 2 M C1 1 H5 ISO 17632-A-T 46 3 M M21 1 H5	✓	✓	✓	✓	-	-	3YSA H5	3YS H5	SA3Y H5	IIIYS H5	-	-	3YS H5	-	
	SC-70T Cored	A5.18 E70C-3C / E70C-6M	ISO 17632-A-T 42 2 M C1 1 ISO 17632-A-T 46 2 M M21 1 H5	✓	✓	✓	✓	-	-	3YSA H10, 3YSA (C)	3YS H10 (C1), 3YS H5 (M21)	SA3YM HH (C1), SA3Y HHH (M21)	IIIYMS H10 (C1), IIIYMS H5(M21)	-	-	-	-	
	SF-71	A5.20 E71T-1C	ISO 17632-A-T 42 0 P C1 1	✓	✓	-	✓	-	2SMG, 2YSMG(C) H10	2SA, 2YSA H10, 2Y400SA	2S, 2YS H10	SA2M, SA2YM HH, A2M, A2YM HH	IIY40MS H10	KSW52G(C) H10 KSW52Y40G(C) H10	2, 2YS H10	2YS H10	2SM, 2YSM H10	2HS, 2YHS
	SF-70MX	A5.20 E70T-1C	ISO 17632-A-T 42 0 R C1 3	✓	-	-	✓	-	2SG, 2YSG (C1) H10, 2MG, 2YMG(C1) H10	2SA, 2YSAH10, 2Y400SA	2S, 2YS H10	SA2YM HH	IIY40MS H10	KSW2G, KSW52Y40G(C) H10 KAW2MG, KAW52MG(C) H10	-	2YS H10	2YSM H10	2HSM, 2YHSM
	Supercored 71	A5.20 E71T-1C	ISO 17632-A-T 42 2 P C1 1	✓	✓	✓	✓	-	3SMG, 3YSMG(C) H10	3SAH10, 3YSA	3YS H10	SA3M, SA3YM, A3M, A3YM HH	IIIYMS H10	KSW53Y40G(C) H10	3YSM H10	3YS H10	-	3YS H10
	SC-71LH	A5.20 E71T-1C/-9C	ISO 17632-A-T 42 2 P C1 1 H5	-	✓	-	✓	-	3YSG(C) H5	3YSA H5	3YS H5	SA3Y HHH	IIIYMS H5	KSW53Y40G(C) H5	3YS H5, 3Y40S H5	3YS H5	-	3YS H5
	SC-71LHM Cored	A5.20 E71T-1M/-9M	ISO 17632-A-T 46 3 P M21 1 H5	✓	✓	✓	✓	-	-	3YSA H5	3YS H5	SA3Y HHH	IIIYMS H5	-	-	-	-	
	SC-420MC	A5.20 E71T-1C H4/-1M H8	ISO 17632-A-T 46 3 P C1 1 H5 ISO 17632-A-T 46 3 P M21 1 H5	-	✓	✓	✓	-	-	-	3YS H5	SA3YM HHH	IIIYMS H5	-	-	3YS H5	-	
	Supercored 71H	A5.20 E71T-1C/-9C/-9C-J	ISO 17632-A-T 42 4 P C1 1 H5	✓	✓	✓	✓	✓	4YSMG(C) H10, 3SMG(C) H10 / 3YSMG(C) H10	4YSA H10, 3YSA H10	4YS H10	SA4YM HH, SA3YM HH	IVYSM H5, IIIYMS H5	KSW54G(C) H10 KSW53G(C) H10	4Y40SM H5, 3Y40SM H5	3YS H10	3YSM H10, 4YSM H10	-
	SC-71MJ	A5.20 E71T-9M-J	ISO 17632-A-T 46 4 P M21 1 H5	-	-	-	-	-	-	4YSA, 4Y400SA H5	4Y40S H5	SA4Y, SA4Y40 HHH	IVY40MS (H5)	-	-	-	-	
	Supercored 70MXH	A5.20 E70T-1C/-9C	ISO 17632-A-T 42 2 R C1 3 H5	-	-	-	-	-	3YSG(C) H5, 3YMG(C) H5	3SA H5, 3YSA	3YS H5	SA3YM, A3YM HHH	IIIYMS H5	KSW53G(C) H5 KAW53MG(C) H5	-	3YS H5	3YSM H5	-
	SC-80K2	A5.29 E80T1-K2C	ISO 17632-A-T 46 6 1.5Ni R C1 3 H5	-	-	-	-	-	4Y40SG(C) H5, 4Y40MG(C)	5Y400SA H5	5Y40S H5, 5Y40M H5	SA5Y40 HHH	VY40MS H5, NV4-4L	KAW54Y40MG(C), KSW54Y40MG(C)H5	5Y40S H5	-	-	
	Supercored 81-K2	A5.29 E81T1-K2C H4	ISO 17632-A-T 46 6 1.5Ni P C1 1 H5	✓	-	-	✓	-	5Y40SG(C) H5, L3SG(C) H5	5Y400SA H5	5Y40S H5	SA5Y40 HHH	VY40MS H5, NV2-4L, 4-4L	KSWL3SG(C) H5 KSW54Y40G(C)H5	5Y40SM H5	5YS H10	5Y40S H5	-
	Supercored 81MAG	A5.29 E81T1-Ni1M H4	ISO 17632-A-T 50 6 1Ni P M21 2 H5	✓	✓	✓	✓	-	-	5Y400SA H5	5Y40S H5	SA5Y40M HHH	VY40MS H5	-	5Y42SM H5	5Y40S H5	-	
SAW	S-777Q / H-14	A5.17 F7A2-EH14	ISO 14174-S A AR 1 / ISO 14171-A-S4	-	-	-	✓	-	-	-	3YM	-	-	-	-	3YM	-	
	Superflux 55ULT / H-14	A5.17 F7A(P)8-EH14	ISO 14174-S A FB 1 / ISO 14171-A-S4	-	✓	✓	✓	-	4Y40M H5 (-60°C ≥ 41 J)	5Y400M H5, 4YT	4YT, 4Y40M H5	AS5Y40M HHH, A4YT	VY40M H5, IVYT / VYT (Tt:20mm)	KAW54T, KAW54Y40M H5	5YT, 4Y40T, 5Y40M H5	5Y40M, 4YT	-	
	Superflux 55ULT / A-3	A5.23 F8TA8-EA3	ISO 14174-S A FB 1 ISO 14171-A-S4Mo	-	-	-	-	-	5Y40M H5, 5YT, 4Y40T	5Y400M H5, 5YT, 4Y40T	4Y, 4Y40, 5Y40	AS5Y40M H5, A5YT, A4Y40T	VY40M H5, VYT, IVY40T	KAW54Y40TMH5, KAW54Y40MH5-60T	5Y40M H5, 5YT, 4Y40T	-	-	
	S-777Q / M-12K	A5.17 F7A2-EM12K	ISO 14174-S A AR 1 / ISO 14171-A-S2Si	-	-	-	✓	-	-	-	3YM	-	-	-	-	3YM	-	

WELDING PROCESS DEVELOPMENT FOR INCREASED PRODUCTIVITY

Welding is an essential technology in modern shipbuilding. It determines to a high degree the production time of a ship and fabricators are continuously searching for more productive and more cost-efficient methods of welding. At the same time, shortage of skilled welders is becoming a headache for an industry where the majority of welding tasks still involves manual and semi-automatic welding.

In close cooperation with the world's largest shipbuilders, HYUNDAI WELDING has developed outperforming consumables solutions to improve productivity in shipbuilding for a number of characteristic labour intensive welding operations.

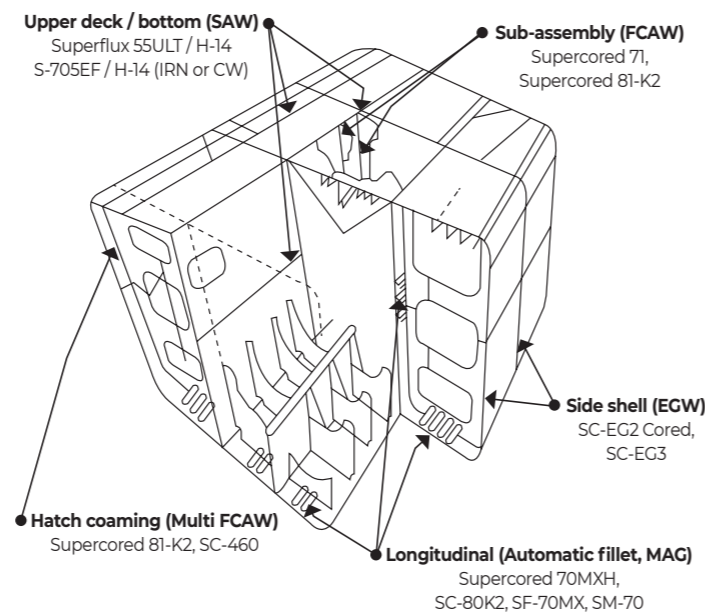

EGW - Electro Gas Welding

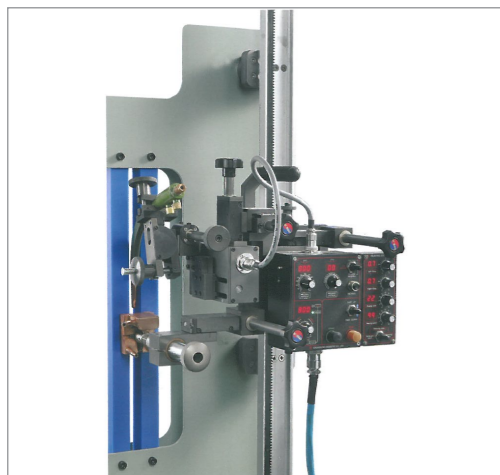

Electro gas welding is a development for the welding of shells in the vertical-up position, typically for the joining of pre-fabricated units in dry dock assembly. These joints are traditionally welded with the semi-automatic FCAW process, which is time-consuming when it concerns thick plate. It is common practice to deposit 40 passes in the multi-pass welding of 70mm plate, for example.

Electro gas welding with specially designed flux-cored wires allows these joints to be welded in a single pass operation, with heat input up to 300 kJ/cm at a deposition efficiency of over 95%. The single layer weld shows a typical solidification structure, but nevertheless features excellent mechanical properties, enabled by the adapted metallurgy of HYUNDAI WELDING's flux cored wires SC-EG2 Cored and SC-EG3. The EGW process and consumables are approved by all ship classification societies (e.g. ABS, BV, DNV, GL, LR).

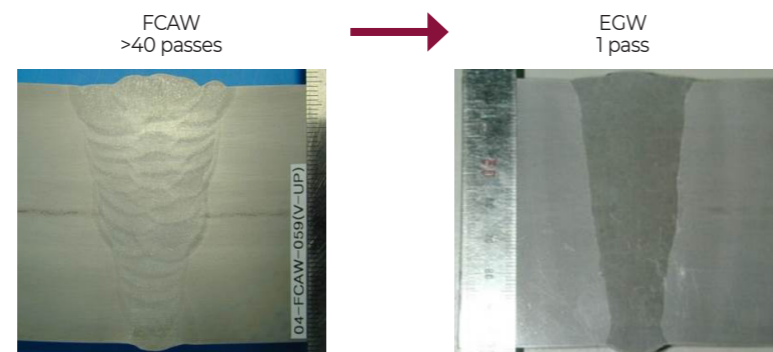
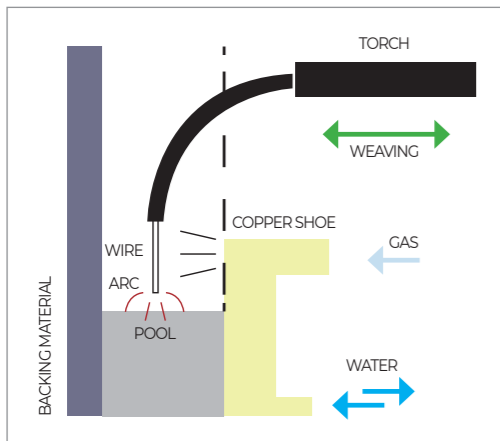

Wall thickness 55 mm

Tandem FCAW – Gantry welding

HYUNDAI WELDING has developed a tandem head solution for the double-sided welding of longitudinal stiffeners on gantry panel lines. It uses an innovative "semi metal-cored" wire, the Supercored 70MXH, for welding T-fillets. In comparison with single head welding, the welding speed increases from 40 to 100 cpm for an a=6 fillet weld (+ 150%).

Supercored 70MXH is specially designed for tandem FCAW. It shows the excellent welding characteristics of a rutile flux-cored wire, but combines this with a very low slag production and is therefore labelled "semi metal-cored". The remaining minimal slag is easily removed from an extremely smooth weld surface. Mechanical properties of the weld are excellent. Supercored 70MXH can be used on zinc-primed or rusty plate, reducing the risk of porosity. See page 20 for detailed product information.

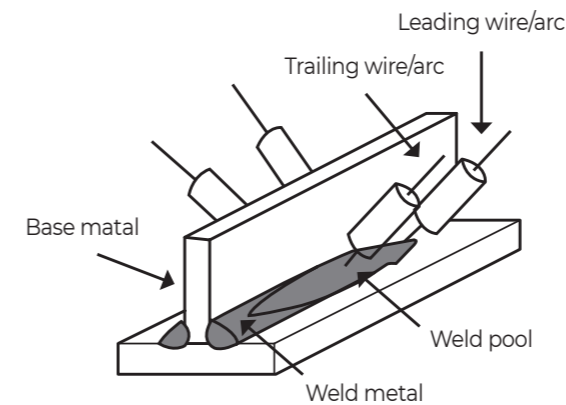

Submerged Arc Welding on FGB (Fiber Glass Backing)

In shipbuilding, TMCP (Thermo Mechanically Controlled Processed) steel is widely used for its fine grain structure and resulting good mechanical properties. To increase productivity in welding TMCP steel, HYUNDAI WELDING has developed the IRN process for one-sided SAW on fibre glass backing. By adding metal powder or cut wire in a controlled way to the weld pool with adapted welding parameters, the deposition rate is stepped-up. The heat input, however, is not increased and mechanical properties remain unaffected. Applying this method, up to 25mm plate thickness can be welded in a single layer, whereas conventional SAW requires at least two layers.

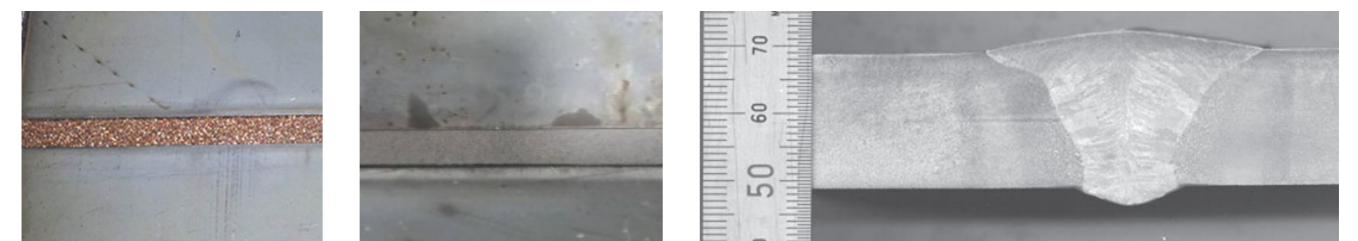
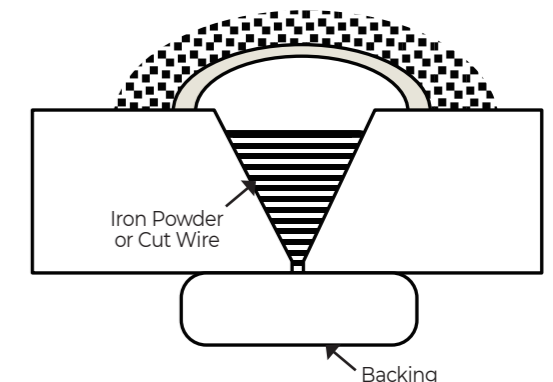

Cut Wire

Iron Powder

SC-420MC

It is a multi-purpose, all-positional rutile flux cored wire for use with either M21 or C1 gas. It can be used in all positions, and its smooth and stable arc promotes spatter-free welds and good cold-crack resistance together with low fume and hydrogen generation. It also has good vertical weldability at low current, and forms a flat stringer bead when using M21 (Ar+20%CO₂) gas.

Weldability

	SC-420MC			
	12mm Fillet 3G(PF) Manual Welding		6mm Vertical Fillet 3G(PF) Auto Welding Carriage	
Shielding Gas	C1 (100% CO ₂)	M21 (Ar+20%CO ₂)	C1 (100% CO ₂)	M21 (Ar+20%CO ₂)
Welding Conditions	200A/26V	200A/25V	180A/26V 25cm/min (9.8in/min)	180A/25V 25cm/min (9.8in/min)
Leg length & Weld throat	-	-	a: 4.8mm b: 5.1mm c: 4.6mm	a: 5.4mm b: 5.2mm c: 4.2mm

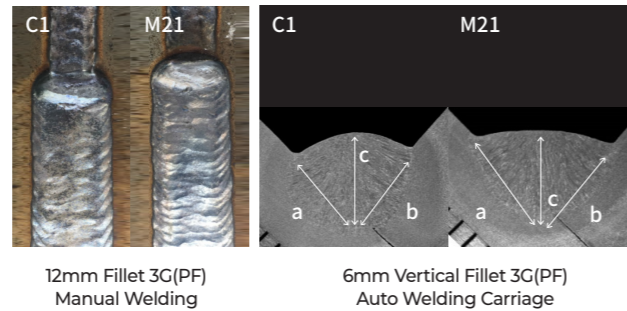

Hydrogen Generation Using Gas Chromatograph Method

Diameter	1.2mm (0.045in)
Welding speed	30cm/min (11.8in/min)
Gas flow	C1 (100%CO ₂) / M21 (Ar+20%CO ₂), 20ℓ/min.
Stick-out	25mm (1in)
Parameters	240A / 27V (C1, 100%CO ₂) 240A / 25V (M21, Ar+20%CO ₂)
Hydrogen Evolution Time	72 hrs
Evolution Temp.	45°C (113°F)
Barometric Pressure	780mm-Hg

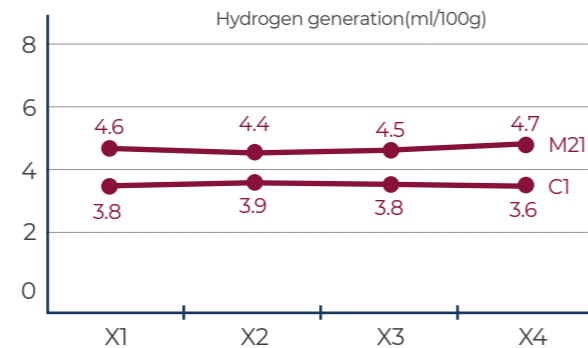

Fume Generation

Diameter	1.2mm (0.045in)
Gas flow	C1 (100%CO ₂) / M21 (Ar+20%CO ₂), 20ℓ/min.
Stick-out	25mm (1in)
Parameters	280A / 32V (C1, 100%CO ₂), 280A / 30V (M21, Ar+20%CO ₂)
Speed	30cm/min (11.8in/min)
Welding time	30s
Fume collection time	2m 30s

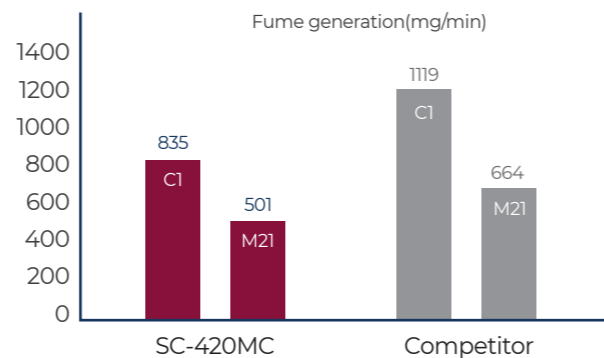

Cold Cracking Resistance

- Y-Groove welding Cracking Test (Modified by EN ISO 17642-2 and JIS Z 3158)
- Base metal Temp : 15~25°C (No Preheat)
- 240A / 27V / 55cm/min(21.7in/min) (Heat Input : 7kJ/cm)
- After welding, the specimen has been cooled under normal conditions for 72 hours.

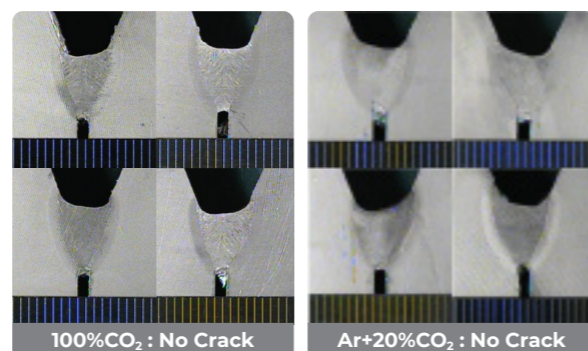

Supercored 71H

All-positional rutile cored wire with excellent characteristics for welding applications in shipbuilding. It features dependable wire feeding and excellent start-stop behaviour along with a smooth, spatter-free arc in 100% CO₂ shielding gas. Very good slag release and minimal post weld labour. The wire has excellent low-temperature toughness down to -40°C and yields low-hydrogen H5, both contributing to the avoidance of hydrogen induced cracking.

Hydrogen Generation Using Gas Chromatograph Method

Diameter	1.2mm (0.045in)
Welding speed	30 cm/min (11.8 in/min)
Gas flow	C1 (100%CO ₂) , 20ℓ/min
Stick-out	25mm (1in)
Parameters	240A / 27V
Hydrogen Evolution Time	72 hrs
Evolution Temp.	45°C (113°F)
Barometric Pressure	780mm-Hg

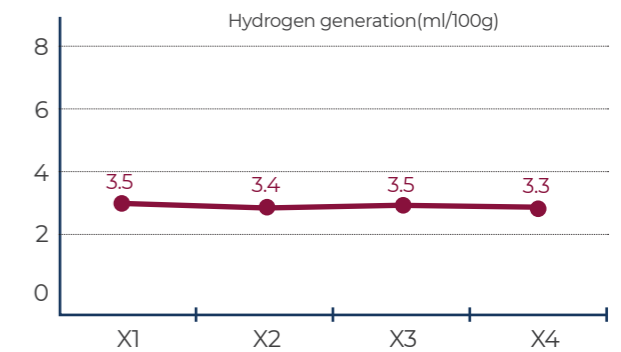

Hot Cracking Resistance

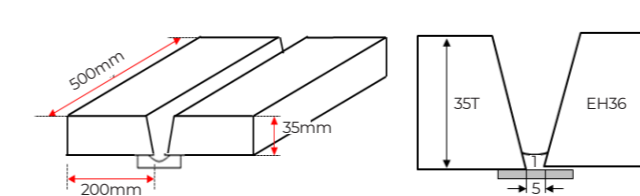

Parameters : 250A/30V



Liquid Penetrant Testing (PT) - No Crack

Cold Cracking Resistance

- Y-Groove welding Cracking Test (Modified by EN ISO 17642-2 and JIS Z 3158)
- Base metal Temp : 15~25°C (No Preheat)
- 240A / 27V / 55cm/min(21.7in/min) (Heat Input : 7kJ/cm)
- After welding, the specimen has been cooled under normal conditions for 72 hours.

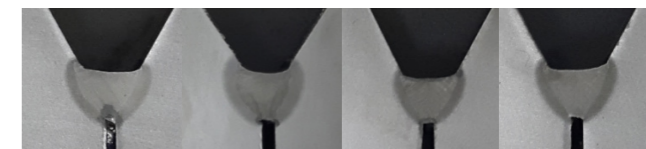

* No Crack

Mechanical Properties of K-Groove

Supercored 71H		Charpy V-notch Impact Values (Joules)					
		40°C (-40°F)					
		X1	X2	X3	X4	X5	Avg.
1G	Face	84	96	108	114	101	105
	Root	85	86	97	97	84	90
3G	Face	88	72	80	68	74	76
	Root	70	82	69	73	75	74

1G position (30T)

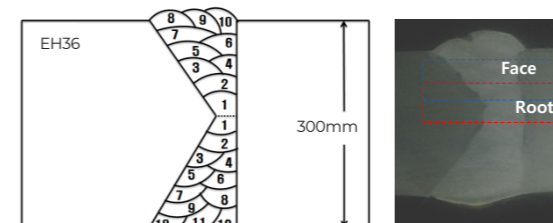

3G position (40T)

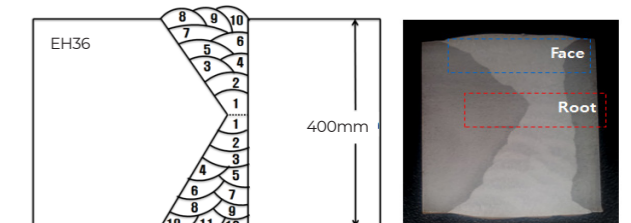

Supercored 70MXH

Semi metal-cored wire specifically designed for single and double-sided tandem welding of longitudinal stiffeners (T-fillets) on gantry panel lines, using tandem-twin welding heads. It shows the excellent welding characteristics of a rutile flux-cored wire, but combines this with a very low slag production and is therefore labelled "semi metal-cored". At around 90%, the weld metal recovery is higher than with standard rutile flux-cored wires. It is welded in 100% CO₂ shielding gas giving the deep and round weld penetration which is favourable for obtaining fillet welds free of fusion defects. The remaining minimal slag is easily removed from an extremely smooth weld surface. Mechanical properties of the weld are excellent. The diffusible hydrogen content of the weld metal is below 5ml/100g. Supercored 70MXH can be used on zinc-primed or rusty plate, reducing the risk of porosity. Welding speed up to 100 cpm can be reached for a 6mm leg length fillet weld.

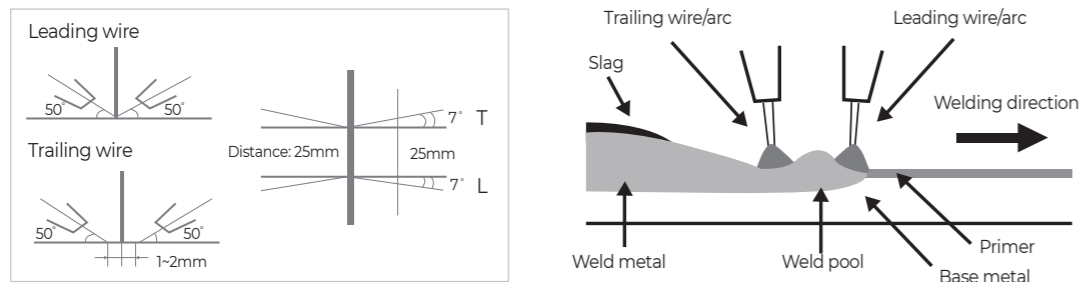
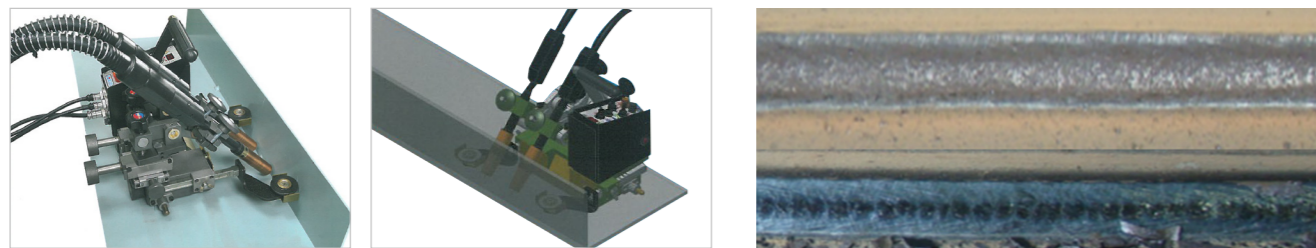

Deposition Rate & Efficiency

Consumable (Size)	Welding Conditions		Wire Feed Speed m/min (in/min)	Deposition Efficiency (%)	Deposition Rate kg/hr (lb/hr)
	Current (A)	Voltage (V)			
Supercored 70MXH 1.4mm (0.052in)	300	31	7.6 (300)	90~92	5.1 (11.2)
	350	36	10.2 (400)	91~93	5.8 (12.8)
	380	36	12.8 (500)	91~93	6.5 (14.3)
Supercored 70MXH 1.6mm (1/16in)	300	33	6.4 (250)	87~89	4.8 (10.6)
	350	36	8.7 (300)	90~91	5.4 (11.9)
	400	38	8.1 (320)	90~91	6.2 (13.6)
	450	42	9.2 (360)	91~92	7.8 (17.2)

Hydrogen Generation Using Gas Chromatograph Method

Diameter	1.6mm (1/16 in)
Welding Speed	30 cm/min (11.8 in/min)
Gas Flow	C1 (100% CO ₂)
Stick-out	20-25 mm (0.79-0.98in)
Parameters	330A / 32V

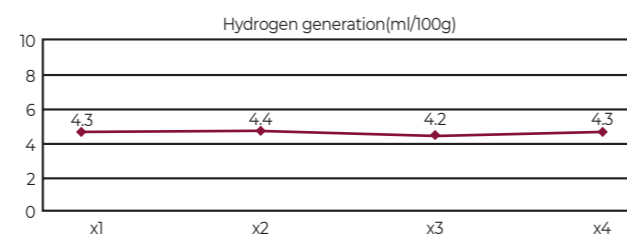

Superflux 55ULT / H-14

Multi-purpose, agglomerated basic submerged arc welding flux for a variety of shipbuilding applications, including LPG tankers. With three different wires it covers different strength levels and CVN impact requirements down to -60°C. CTOD-tested in -10°C. It is suited for the welding of single runs on fibre glass, double-sided single runs and for multi-run applications with single, tandem or twin-wire heads. It deposits TiB micro-alloyed weld metal with a high purity and a fine-grain micro structure which is extremely cracking resistant.

3 types of wire combinations → 1 Flux meets diverse requirements

Flux	Wire	AWS Spec.	Base metal
Superflux 55ULT	H-14	A5.17 F7A(P)8-EH14	AH32/36/40 DH32/36/40 EH32/36/40 FH32/36/40(Multi-run)
	A-G	A5.23 F8A(P)8-EG-G	AH42/42 DH42/42 EH42/42
	A-3	A5.23 F8A6-EA3-G A5.23 F8TA8-EA3	FH32/36/40(Two-run)

EH36 20T I-Butt (Superflux 55ULT / H-14)

Thickness	Welding Conditions						
	Croove	Position	Polarity	Current (A)	Voltage (V)	Travel Speed CPM (IPM)	Heat Input kJ/cm (kJ/in)
20t		Face	DC+	1250	36	100 (39.4)	46.2 (117.3)
			AC	800	40		
		Root	DC+	1350	36	100 (39.4)	48.4 (122.9)
			AC	800	40		



Product	CVN Impact Test (Joule)					
	Position	Temp °C (°F)	X1	X2	X3	Avg.
Superflux 55ULT / H-14	Face	-20 (-4)	164	152	141	152
		-40 (-40)	89	72	100	87
	Root	-20 (-4)	134	136	143	138
		-40 (-40)	99	72	54	75

Tandem Weldability

No.	(A/V/CPM)	Bead	Macro Image (penetration, mm)	Bead	
				Width	Depth
1	L(DC+) 810/36/135 T(AC) 650/40			16mm	6mm
2	L(DC+) 850/36/150 T(AC) 700/42			16mm	6mm
3	L(DC+) 800/35/150 T(AC) 700/44			18mm	6.5mm

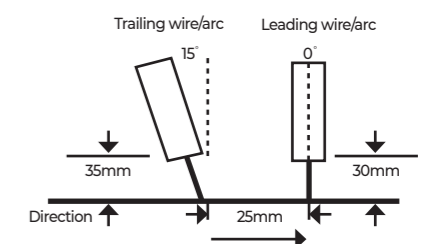

FLUX CORED WIRES FOR LOW TEMPERATURE APPLICATIONS IN LPG CARRIERS

LPG Carriers are vessels specifically designed and built to transport liquefied petroleum gas (LPG) in large quantities. The main constituents of LPG are propane and butane. It is produced during natural gas processing and refining.

LPG has a boiling point ranging from -30 to -48 °C at which temperature it can be liquefied and transported in fully refrigerated tanks. LPG carriers with prismatic tanks are most commonly used for shipping. These tanks are usually constructed from low-alloyed steel with good low-temperature toughness, such as according to ASTM A537 class 1,2 &3 and DNV NV 2-4.

HYUNDAI WELDING offers a complete portfolio of flux-cored wires for LPG applications, offering guaranteed impact properties in both the as welded and post weld heat treated (PWHT) condition.



Typical Chemical Composition of All-Weld Metal (%)

	Product	C	Si	Mn	P	S	Ni
1.5% Ni type	Supercored 81-K2	0.04	0.35	1.35	0.01	0.01	1.5
	SC-81SR	0.05	0.28	1.2	0.012	0.011	1.5
	SC-80K2	0.06	0.43	1.45	0.011	0.008	1.57
4% Ni type	SC-71Ni4	0.03	0.22	1.30	0.010	0.008	3.2
	SC-81Ni4	0.04	0.29	0.90	0.010	0.008	3.4

Typical Mechanical Properties of All-Weld Metal

	Product	AWS A5.29	EN ISO 17632-A	Condition	YS (MPa)	TS (MPa)	Elongation (%)	CVN-Impact	
								°C (°F)	Value J (ft/lbs)
1.5% Ni type	Supercored 81-K2	E81T1-K2C H4	T 46 6 1.5Ni P C 1 H 5	As Welded	540	620	28	-60 (-76)	60 (44)
	SC-81SR	E81T1-K2C	T 46 6 1.5Ni P C 1 H 5	As Welded PHWT(620 °C*2hr)	580 560	620 600	28 32	-60 (-76) -60 (-76)	90 (66) 70 (52)
	SC-80K2	E80T1-K2C	T46 6 1.5Ni R C 1 3 H 5	As Welded	575	635	26.5	-60 (-76)	60 (44)
4% Ni type	SC-71Ni4	A5.29 E71T1-GC	ISO 17632-A-T 42 6 Z P C 1 H 5	As Welded	540 (78,300)	600 (87,000)	27	-60 (-75)	85 (63)
	SC-81Ni4	A5.29 E81T1-GC	ISO 17632-A-T 46 6 Z P C 1 H 5	As Welded	580 (84,100)	640 (92,900)	26	-60 (-75)	80 (59)

SC-80K2 is suitable for high speed single or twin tandem welding
All wires are suitable for C1 (100 CO₂) shielding gas

WELDING CONSUMABLES FOR OUTFITTING

Outfitting in shipbuilding refers to the process of installing components inside a ship or vessel. It involves the completion of interior work after the main structure of the ship has been constructed. Outfitting encompasses a wide range of activities, including the installation of machinery, equipment, and systems required for the operation of the ship, as well as the incorporation of accommodations and facilities for crew and passengers.

All modern shipyards are today adopting the concept of advanced outfitting. This enables reduction of the building cycle time of a vessel and accounts for substantial costs savings, depending on the availability of infrastructure at the yards. Different concepts have been developed for the pre-outfitting in the block building stage. Block outfitting involves the placing of components on large blocks of the hull before the blocks are erected and welded to each other. Such a component may be a unit of a pump or a boiler with its seating and associated piping.



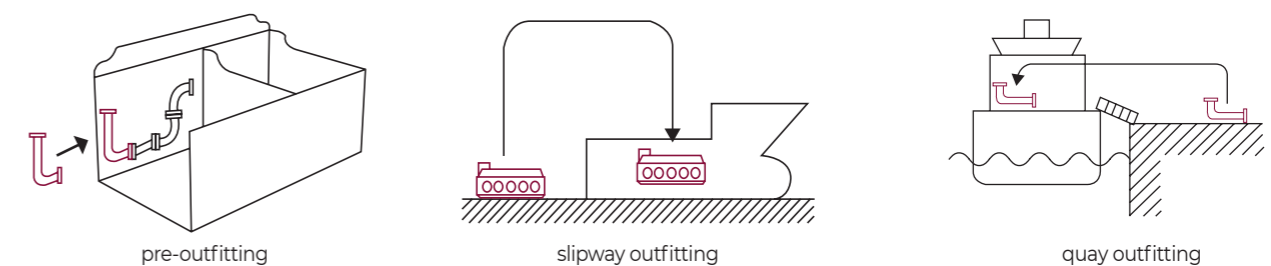

It is important to note that welding processes and techniques for pre-outfitting may depend on the shipyard, the type of ship being constructed, and on any applicable regulatory requirements. The table below gives an overview of HYUNDAI WELDING products used for outfitting by shipbuilders all over the world.

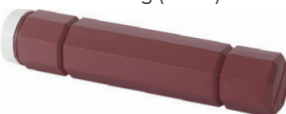

Process	Product Name	Specification	
		AWS	EN
SMAW	S-6013.LF	A5.1 E6013	ISO 2560-A-E38 0 R 12
	S-7018.1	A5.1 E7018-1	ISO 2560-A-E42 4 B 3 2
	S-7018.1H	A5.1 E7018-1 H4R	ISO 2560-A-42 4 B 3 2 H5
	S-308L.16N	A.5.4 E308L-16	ISO 3581-A-E 19 9 L R
	S-309L.16	A5.4 E309L-16	ISO 3581-A-E 23 12 L R
	S-316L.16N	A5.4 E316L-16	ISO 3581-A-E 19 12 3 L R
	S-2209.16	A5.4 E2209-16	ISO 3851-A-E 22 9 3 N L
GMAW	SM-308L	A5.9 ER308L	ISO 14343-A G 19 9 L
	SM-316L	A5.9 ER316L	ISO 14343-A G 19 12 3 L
GTAW	ST-50G	A5.18 ER70S-G	ISO 636-A-W3SiI
	ST-IN	A5.28 ER80S-NiI	ISO 636-A W 46 5 Z3NiI
	ST-308L	A5.9 ER308L	ISO 14343-A W 19 9 L
	ST-309L	A5.9 ER309L	ISO 14343-A W 23 12 L
	ST-316L	A5.9 ER316L	ISO 14343-A W 19 12 3 L
FCAW	ST-347	A5.9 ER347	ISO 14343-A W 19 9 Nb
	SMT-7030	A5.7 ERCuNi	-
	SW-308L Cored	A5.22 E308LT1-1/-4	ISO 17633-A-T 19 9 L P M21/C1 2
	SW-309L Cored	A5.22 E309LT1-1/-4	ISO 17633-A-T 23 12 L P M21/C1 2
	SW-309MoL Cored	A5.22 E309LMoT1-1/-4	ISO 17633-A-T 23 12 L P M21/C1 2
FCAW	SW-316L Cored	A5.22 E316LT1-1/-4	ISO 17633-A-T 19 12 3 L P M21/C1 2
	SW-2209 Cored	A5.22 E2209T1-1/-4	ISO 17633-A-T 22 9 3 N L M21/C1 2

SMAW Electrodes

Type	Packet	Carton								
STANDARD	 <p>5kg</p>	 <p>20kg</p> <table border="1"> <thead> <tr> <th colspan="2">Carton Size mm (in)</th> </tr> </thead> <tbody> <tr> <td>d</td> <td>82 (3.2)</td> </tr> <tr> <td>e</td> <td>180-275 (7.1-10.8)</td> </tr> <tr> <td>f</td> <td>312-562 (12.3-22.1)</td> </tr> </tbody> </table>	Carton Size mm (in)		d	82 (3.2)	e	180-275 (7.1-10.8)	f	312-562 (12.3-22.1)
	Carton Size mm (in)									
d	82 (3.2)									
e	180-275 (7.1-10.8)									
f	312-562 (12.3-22.1)									
	 <p>5kg</p>									
ALUMINUM VACUUM PACK	 <p>1.5kg</p>	 <p>15kg</p> <table border="1"> <thead> <tr> <th colspan="2">Carton Size mm (in)</th> </tr> </thead> <tbody> <tr> <td>d</td> <td>96 (3.8)</td> </tr> <tr> <td>e</td> <td>260 (10.2)</td> </tr> <tr> <td>f</td> <td>470-570 (18.5-22.4)</td> </tr> </tbody> </table>	Carton Size mm (in)		d	96 (3.8)	e	260 (10.2)	f	470-570 (18.5-22.4)
			Carton Size mm (in)							
d	96 (3.8)									
e	260 (10.2)									
f	470-570 (18.5-22.4)									

Type	Packet	Carton																								
PVC BOX (HEXAGONAL)	 <p>2.5kg (5.5lbs)</p>	 <p>10-20kg (22-44lbs)</p> <table border="1"> <thead> <tr> <th colspan="3">Carton Size mm (in)</th> </tr> </thead> <tbody> <tr> <td>Packet</td> <td>PVC 2.5kg (5.5lbs)</td> <td>Can 4.5kg (9.9lbs)</td> </tr> <tr> <td>Carton</td> <td>10kg (22lbs)</td> <td>18kg (39.7lbs)</td> </tr> <tr> <td></td> <td>20kg (44.1lbs)</td> <td>PVC 5kg (11lbs)</td> </tr> <tr> <td>d</td> <td>80 (3.1)</td> <td>85 (3.3)</td> </tr> <tr> <td>e</td> <td>310-330 (12.2-13)</td> <td>317 (12.5)</td> </tr> <tr> <td>f</td> <td>360-405 (14.2-16)</td> <td>383-433 (15.1-17)</td> </tr> <tr> <td></td> <td>325-375 (12.8-14.8)</td> <td></td> </tr> </tbody> </table>	Carton Size mm (in)			Packet	PVC 2.5kg (5.5lbs)	Can 4.5kg (9.9lbs)	Carton	10kg (22lbs)	18kg (39.7lbs)		20kg (44.1lbs)	PVC 5kg (11lbs)	d	80 (3.1)	85 (3.3)	e	310-330 (12.2-13)	317 (12.5)	f	360-405 (14.2-16)	383-433 (15.1-17)		325-375 (12.8-14.8)	
Carton Size mm (in)																										
Packet	PVC 2.5kg (5.5lbs)	Can 4.5kg (9.9lbs)																								
Carton	10kg (22lbs)	18kg (39.7lbs)																								
	20kg (44.1lbs)	PVC 5kg (11lbs)																								
d	80 (3.1)	85 (3.3)																								
e	310-330 (12.2-13)	317 (12.5)																								
f	360-405 (14.2-16)	383-433 (15.1-17)																								
	325-375 (12.8-14.8)																									
TIN CAN	 <p>4.5kg (9.9lbs)</p>																									
PVC BOX (SQUARE)	 <p>5kg (11lbs)</p>																									

Subarc Wire

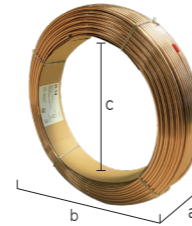
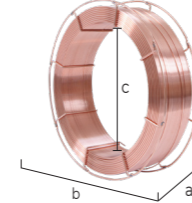
Type	Wire	Size mm (in)			
		Wire	a	b	c
Coil Type		25kg (55lbs)	75/100 (3.0/3.9)	410/420 (16.1/16.5)	305/315 (12.0/12.4)
		30kg (66lbs)	95 (3.7)	400 (15.7)	305 (12.0)
		100kg (220lbs)	90/100 (3.5/3.9)	760 (29.9)	630 (24.8)
Basket Spool		150kg (330lbs)	90 (3.5)	790 (31.1)	630 (24.8)
		25kg (55lbs)	103 (4.1)	413-419 (16.3-16.5)	297-303 (11.7-11.9)

* Other coil sizes available upon request

Subarc Flux

Packaging		
TIN CAN	PE BAG	PAPER BAG
		
15kg, 20kg (33lbs, 44lbs)	20kg, 25kg (44lbs, 55lbs)	20kg, 25kg (44lbs, 55lbs)

GMAW / MIG and Flux Cored Wires

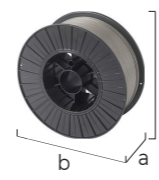
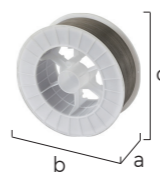
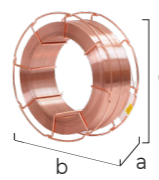
Type	Spool		Spool Size mm (in)			
	Plastic Spool (GMAW / MIG wires / Flux Cored wires)	12.5kg (27.6lbs) / 15kg (33lbs)	Basket Spool (GMAW MIG wires)	15kg (33lbs)		
Spool Type				Plastic Spool (GMAW / MIG wires / Flux Cored wires)	Basket Spool (GMAW MIG wires)	
				a	110 (4.3)	98 (3.9)
				b	270-280 (10.6-11.0)	298 (11.7)
c	270-280 (10.6-11.0)	298 (11.7)				

REFERENCES



HYUNDAI WELDING is a global manufacturer of welding consumables and equipment. As the top leading manufacturer of welding consumables in Korea, and with a global network of sales, distribution and manufacturing plants, HYUNDAI WELDING has developed into a key player in the international welding industry.

Our company is fully committed to the ever-changing needs of our customers and has evolved in just under 50 years to provide welding expertise and breakthroughs in welding technology. HYUNDAI WELDING understands customer needs and offers customers world-class products and world-class solutions.

HYUNDAI WELDING's shipbuilding welding solutions meet customer requirements for ship fabrication backed with a superior customer service and support. By using high quality consumables and equipment portfolio of HYUNDAI WELDING, our customers experience improved productivity and competitiveness in the market.



HYUNDAI WELDING is a world-class manufacturer that specializes in providing optimum welding solutions to its customers, by supplying top-notch welding consumables and equipment. **HYUNDAI WELDING** has contributed to the development and success of the global welding industry for almost 50 years since its foundation in 1975.

For more information on **HYUNDAI WELDING**, please visit www.hyundaiwelding.com



HYUNDAI WELDING CO., LTD. (HEAD OFFICE)
WeWork Bldg. 16th Fl. 507, Teheran-Ro, Gangnam-Gu, Seoul
Tel: (+82-2) 6230-6032~35, 51~68, 76~81 Fax: (+82-2) 522-2030, 525-7317